

PARACHILNA

PRODUCT CATALOGUE

PARACHILNA

Introduction

p001

Designers

p005

Collections

p014

Aballs

by Jaime Hayon

p026

Alistair

by Jordi Veciana

p032

Alta Costura

by Josep Aregall

p038

Anwar

by Stephen Burks

p044

B15

by Jordi Veciana

p050

Babel

by Stephen Burks

p056

Bai

by Neri&Hu

p066

Chinoz

by Jaime Hayon

p072

Denglong

by Neri&Hu

p078

Gweilo

by Partisans

p088

Lighto

by Jaime Hayon

p098

Ma-Rock

by Jaime Hayon

p104

Manila

by Sebastian Herkner

p112

Oïphorique

by Atelier Oi

p120

Petra

by Jordi Veciana

p126

Topuro

by Guido Valín

Family Legacy

Though Parachilna was founded in 2013, it's built on a legacy that dates back to the 1930s, when the Riera family first stepped into the world of lighting. Three generations later, we continue that journey—with a renewed spirit and a vision rooted in craftsmanship, innovation, and design culture.

Parachilna is a platform for bold ideas. We collaborate with designers and artisans who challenge convention, blending tradition with experimentation. Through light, we explore emotion, material, and meaning—always aiming to create objects that feel both timeless and forward-thinking.

Humble luxury

At Parachilna, we believe true quality takes time. It comes from patience, intention, and a deep respect for craft. We embrace the process — sketches, tests, adjustments — knowing there's beauty in every step, not just the final piece.

But precision doesn't mean rigidity. We leave space for play, for mistakes, for joy. We don't take ourselves too seriously, and that freedom fuels creativity. What we create has soul because it's shaped by honesty, humility, and a genuine love for the journey.

Off the grid from Barcelona

Parachilna is based in Barcelona, a city where tradition and innovation have always gone hand in hand. Just outside, in the industrial area of Colonia Güell — once shaped by Gaudí — we work in a space full of history and quiet energy that naturally flows into what we create.

Our name comes from a remote town on the edge of the Australian desert, a symbol of how we see ourselves: on the border of the known, always exploring. We turn bold ideas into real objects, giving them shape here, in the heart of Barcelona.





All products are Made in Spain.

For sustainability purposes and long-term durability, our collections are fully demountable and repairable.



Atelier Oi

Atelier Oi is the result of an alliance of three, rooted in humanity and art alike. It is about sharing values and ideals. The trio has been linked for 25 years through the intangible bond of the desire to grow and venture together on a journey that never denies their individual paths. Their alliance brings together open and creative minds, sharing their visions.

Collection: Oïphorique



Jaime Hayon

After several years working in various interior design studios in Barcelona and teaching in the Master's in Spatial Design, Guido, has been independently developing his own products with the aim of creating unique lighting objects, guided by the sole principle of finding a core concept that structures the entire project and remains present throughout the process and final outcome.

Collection: Aballs, Chinoz, Lighto, Ma-Rock



Jordi Veciana

Jordi Veciana is an industrial designer based in Barcelona, specializing in lighting, product design, and architecture. After earning his degree in Barcelona, he gained experience with designers like Massimo Vignelli and Ralph Lauren in New York. In 1998, he opened his own studio focused on lighting, hospitality, and retail design. In 2017, he co-founded with Skye Maunsell, a network for creative communities, and they collaborate on various design projects.

Collection: Alistair, B15, Petra



Guido Valin

After several years working in various interior design studios in Barcelona and teaching in the Master's in Space Design, Guido, has been independently developing his own products with the aim of creating unique lighting objects, guided by the principle of finding a core concept that structures the entire project and remains present throughout the process and final outcome.

Collection: Topuro

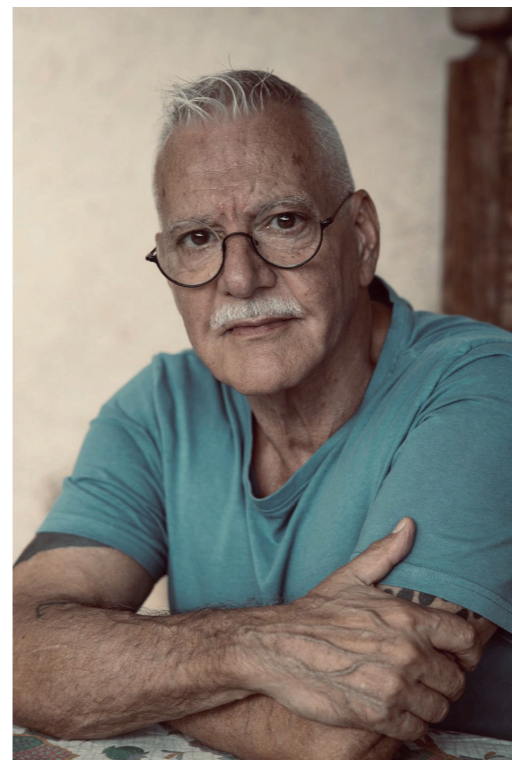

Josep Aregall

Josep Aregall Fusté (Barcelona, 1957) is a Catalan interior designer. He studied at the Eina School in Barcelona, where he earned his degree in interior design in 1977. He began his career collaborating in the studio of Pepe Cortés. In 1983, he established his own studio, working on interior design, product design, temporary installations, and visual merchandising. Much of his work has focused on commercial interiors, particularly the development of retail store chains.

Collection: Alta Costura

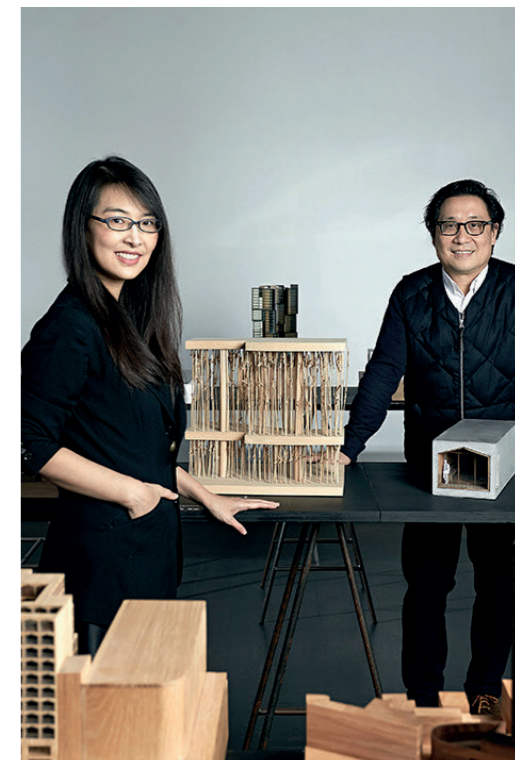

Neri&Hu

Neri&Hu works internationally providing architecture, interior, master planning, graphic, and product design services. Currently working on projects in many countries, Neri&Hu is composed of multi-cultural staff who speak over 30 different languages. The diversity of the team reinforces a core vision for the practice: to respond to a global worldview incorporating overlapping design disciplines for a new paradigm in architecture.

Collection: Bai, Denglong



Partisans

PARTISANS is an award-winning Toronto-based architecture studio that specializes in the integration of design and technology, invention and programming, culture and creative services. Led by Alex Josephson, Pooya Baktash and Jonathan Friedman, the studio is a diverse team of architects, researchers, storytellers, entrepreneurs, builders, and cultural enthusiasts devoted to a cause: smart, high-performance design that strives to make the improbable possible.

Collection: Gweilo



Sebastian Herkner

Sebastian Herkner (born 1981) studied Product Design at HfG Offenbach University of Art and Design. During his studies he began to focus on designing objects and furniture, honing his keen sense for materials, colors and textures. In the year 2006 Sebastian Herkner founded his own studio. Since that time, he has designed furniture, lamps and smaller items.

Collection: Manila



Stephen Burks

Stephen studied architecture at the Illinois Institute of Technology and Product Design at IIT'S Institute of Design, as well as attending Columbia University's Graduate School of Architecture. After years spent traveling between New York and Europe, as well as living abroad in Tokyo & Milan, Stephen became an independent designer at the turn of the millennium, when the famed Italian manufacturer Cappellini put his first pieces into production.

Collection: Anwar, Babel



01	Aballs	by Jaime Hayon	p014
02	Alistair	by Jordi Veciana	p026
03	Alta Costura	by Josep Aregall	p032
04	Anwar	by Stephen Burks	p038
05	B15	by Jordi Veciana	p044
06	Babel	by Stephen Burks	p050
07 ●	Bai	by Neri&Hu	p056
08	Chinoz	by Jaime Hayon	p066
09 ●	Denglong	by Neri&Hu	p072
10	Gweilo	by Partisans	p078
11	Lighto	by Jaime Hayon	p088
12	Ma-Rock	by Jaime Hayon	p098
13	Manila	by Sebastian Herkner	p104
14	Oïphorique	by Atelier Oi	p112
15	Petra	by Jordi Veciana	p120
16 ●	Topuro	by Guido Valín	p126

● Available for Outdoors



Aballs

designed by Jaime Hayon

2013

The Collection

Aballs balances the refinement of ceramics with the softness of opal blown glass. Its timeless design and finishes in black, white, and gold adapt to various applications: table, suspension, wall, and chandelier in different sizes.

Products

Aballs T PE

Aballs T ME

Aballs T GR

Aballs Chandelier 4

Aballs Chandelier 8

Aballs Chandelier 12

Aballs M PE

Aballs M GR

Aballs A

Aballs A II PE

Aballs A II ME

Aballs A II GR

Discover more



- (01) Rotary light dimmer in the ceramic body
- (02) Handmade Italian ceramics from manufacturer Bosa®
- (03) Opal blown glass
- (04) 24 kt gold paint used for the golden finish

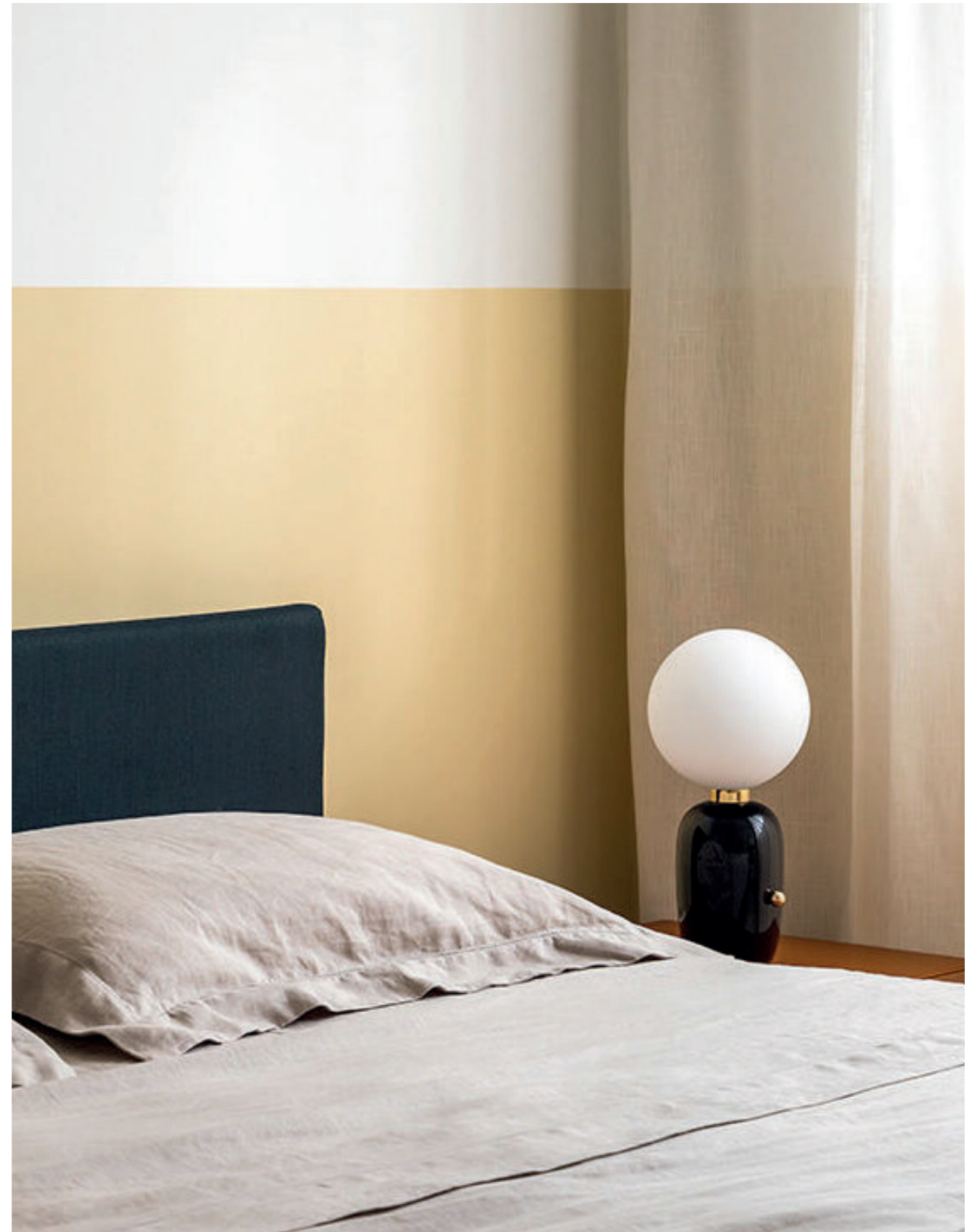

Production video





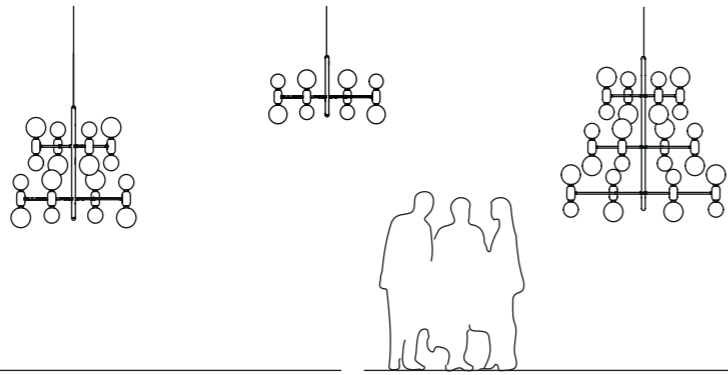

Aballs Chandelier 12

Aballs Chandelier 8

Aballs Chandelier 4

Aballs M GR

Aballs M PE

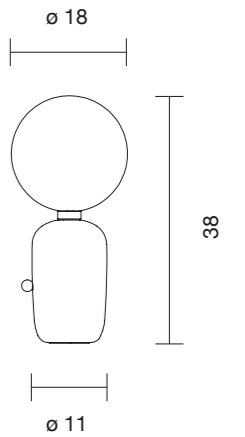
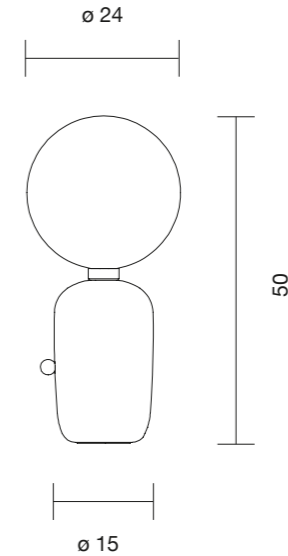
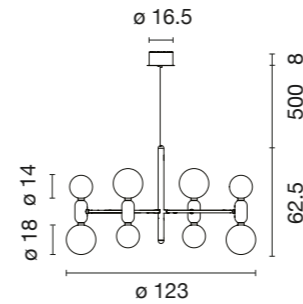
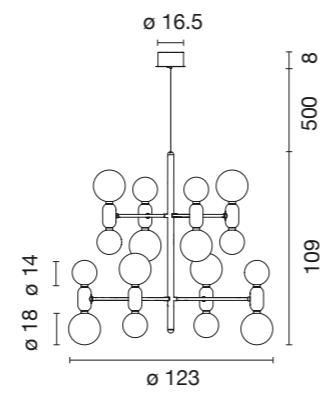
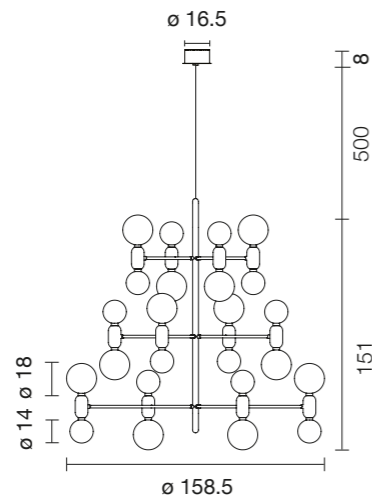

Type
Material
Light Source
Voltage
Dimming
IP Rating
Finishes

Suspension
Ceramic, Steel, Glass
24x G9 LED 4W (Not included)
110V, 220V
Terminal Strip
20
White
Black
Golden

Suspension
Ceramic, Steel, Glass
16x G9 LED 4W (Not included)
110V, 220V
Terminal Strip
20
White
Black
Golden

Suspension
Ceramic, Steel, Glass
8x G9 LED 4W (Not included)
110V, 220V
Terminal Strip
20
White
Black
Golden

Table
Ceramic, Glass
G9 Halo. MAX. 4W (Not included)
110V, 220V
Rotary dimmer on ceramic
20
White
Black
Golden

Table
Ceramic, Glass
G9 Halo. MAX. 4W (Not included)
110V, 220V
Rotary dimmer on ceramic
20
White
Black
Golden

Net Weight
Gross Weight

36.8 kg
77.1 kg

24.3 kg
53.6 kg

13.1 kg
28.9 kg

6.2 kg
9.2 kg

2.9 kg
5.8 kg

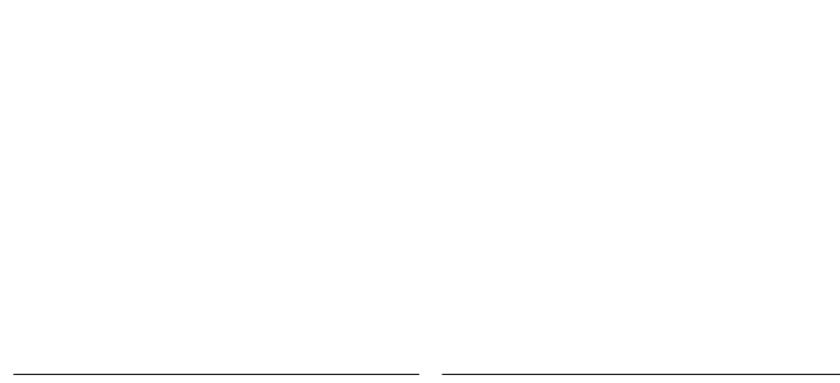

Aballs T GR

Aballs T ME

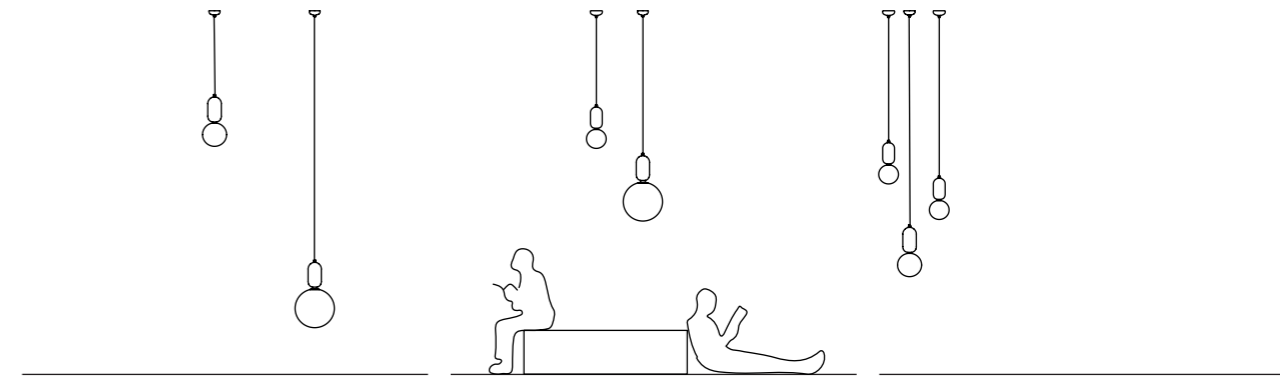
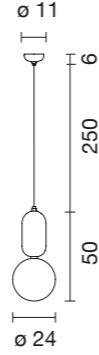
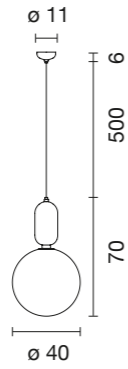

Aballs T PE

Aballs A

Aballs A II GR

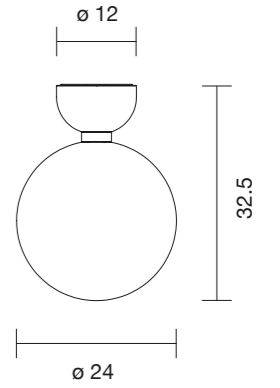
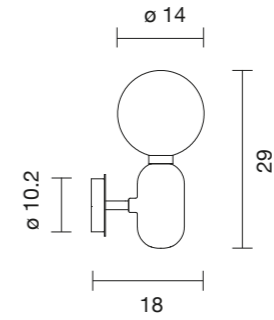
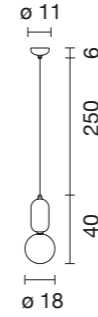

Type	Suspension
Material	Ceramic, Glass
Light Source	E27 LED 15W (Not included)
Voltage	110V, 220V
Dimming	Terminal Strip
IP Rating	20
Finishes	White Black Golden
Net Weight	5.2 kg
Gross Weight	7.8 kg

Type	Suspension
Material	Ceramic, Glass
Light Source	G9 LED 4W (Not included)
Voltage	110V, 220V
Dimming	Terminal Strip
IP Rating	20
Finishes	White Black Golden
Net Weight	4.1 kg
Gross Weight	5.7 kg

Type	Suspension
Material	Ceramic, Glass
Light Source	G9 LED 4W (Not included)
Voltage	110V, 220V
Dimming	Terminal Strip
IP Rating	20
Finishes	White Black Golden
Net Weight	2.1 kg
Gross Weight	3.6 kg

Type	Wall
Material	Ceramic, Glass, Steel
Light Source	G9 LED 4W (Not included)
Voltage	110V, 220V
Dimming	Terminal Strip
IP Rating	20
Finishes	White Black Golden
Net Weight	1.7 kg
Gross Weight	2.6 kg

Type	Wall / Ceiling
Material	Ceramic, Glass
Light Source	G9 LED 4W (Not included)
Voltage	110V, 220V
Dimming	Terminal Strip
IP Rating	20
Finishes	White Black Golden
Net Weight	3.5 kg
Gross Weight	4.3 kg

Aballs A II ME

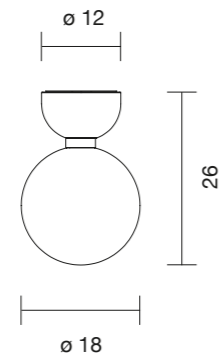

Aballs A II PE

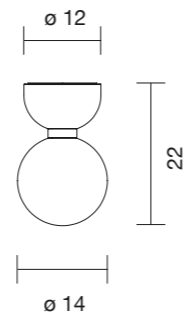

Type
Material
Light Source
Voltage
Dimming
IP Rating
Finishes

Wall / Ceiling
Ceramic, Glass
G9 LED 4W (Not included)
110V, 220V
Terminal Strip
20
White
Black
Golden

Net Weight
Gross Weight

1.4 kg
3.1 kg

Wall / Ceiling
Ceramic, Glass
G9 LED 4W (Not included)
110V, 220V
Terminal Strip
20
White
Black
Golden

1.1 kg
2.2 kg





Alistair

designed by Jordi Veciana

2013

The Collection

Crafted from steel and hand-blown glass, the Alistair collection blends structural precision with soft, diffused light. Available in table and floor versions, its golden finish enhances any space with a contemporary presence.

Products

Alistair M
Alistair P

Discover more





Versatile & minimalist shape, composed of an opal blown glass diffuser and a steel frame.

Alistair P

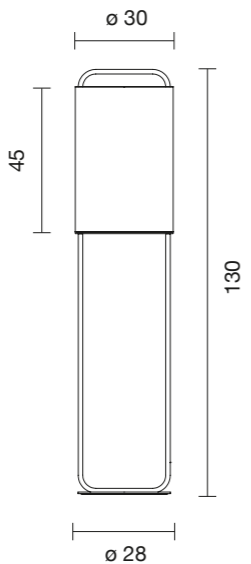

Floor
 Steel, Glass
 E27 LED 15W Dimm. (Not included)
 110V, 220V
 Dimmer switch on cable
 20
 Golden Matte

9.9 kg
 17.4 kg

Alistair M

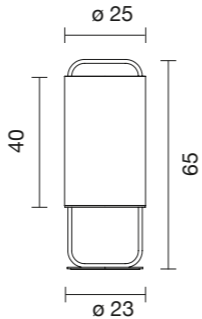

Table
 Steel, Glass
 E27 LED 15W Dimm. (Not included)
 110V, 220V
 Dimmer switch on cable
 20
 Golden Matte

5.8 kg
 9.3 kg

Type
 Material
 Light Source
 Voltage
 Dimming
 IP Rating
 Finishes

Net Weight
 Gross Weight





Alta Costura

designed by Josep Aregall

1992

The Collection

Inspired by haute couture, this collection plays with material tension—steel provides stability while the PVC-coated paper shade twists fluidly. The result is a lighting piece that is both functional and expressive.

Products

Talla 3
Costura
Alta Costura

Discover more





The diffuser that wraps around the mast is made of paper coated PVC providing a warm and cosy light.



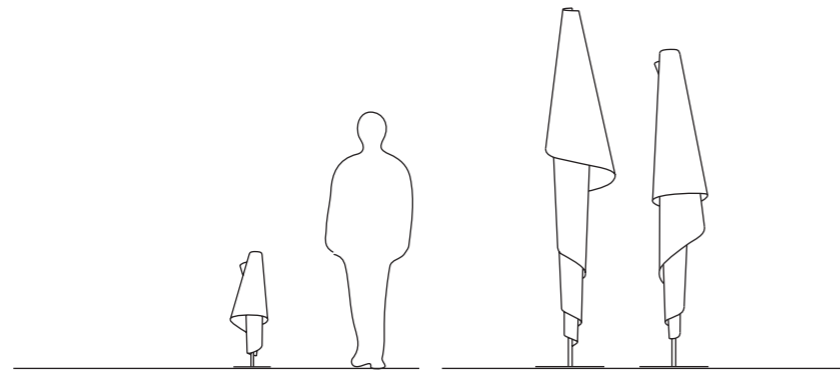

Alta Costura

Costura

Talla 3

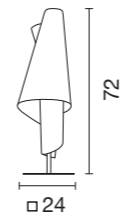
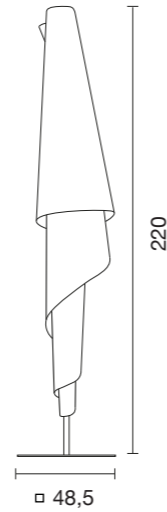
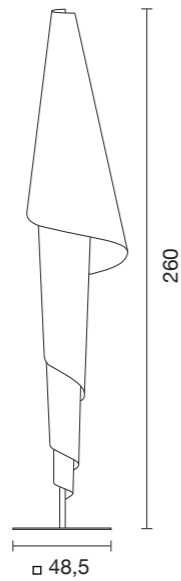

Type
Material
Light Source

Voltage
Supply
IP Rating
Finish

Net Weight
Gross Weight

Floor
Steel, PVC Coated Paper
2x Linestras LED 100cm S14s 16W
(Not included)

110V, 220V
On/Off switch on cable
20
Matte Black

17.5 kg
20.5 kg

Floor
Steel, PVC Coated Paper
Linestra LED 50cm S14s 8W +
Linestra LED 100cm S14s 16W
(Not included)

110V, 220V
On/Off switch on cable
20
Matte Black

16.9 kg
20 kg

Table
Steel, PVC Coated Paper
Linestra LED 30cm S14s 5W

110V, 220V
On/Off switch on cable
20
Matte Black

3 kg
4.2 kg



Anwar

designed by Stephen Burks

2013

The Collection

Anwar was inspired by traditional african wicker baskets. Its intricate design forms a captivating lattice structure, creating a dynamic visual effect. Available in 3 different oval shapes, they can also be combined.

Products

- Anwar T 45
- Anwar T 30
- Anwar T 90
- Anwar T Combination

Discover more





Production video



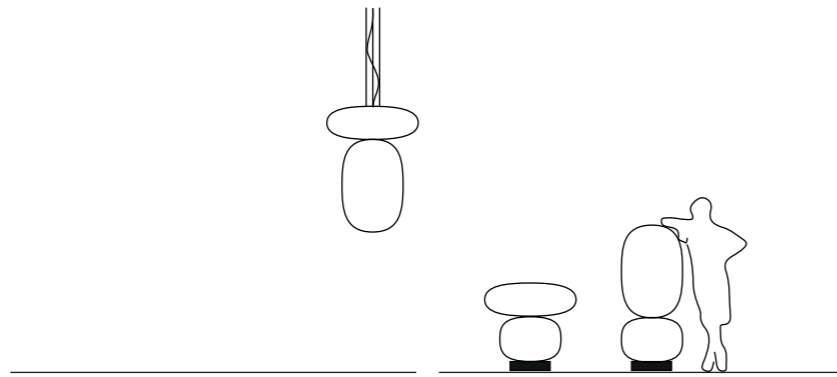

Anwar T 30

Anwar T 45

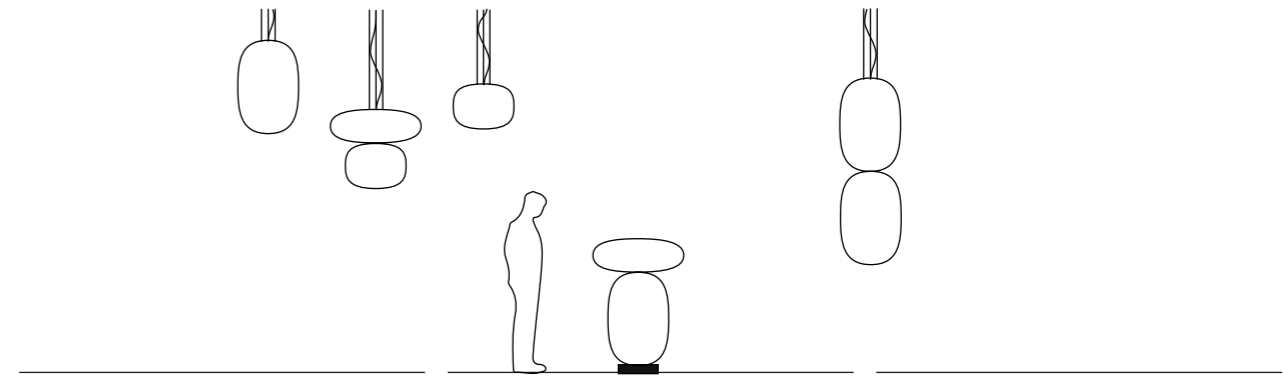

Anwar T 90

Anwar T Combination

Anwar P Combination

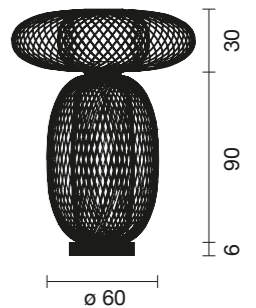
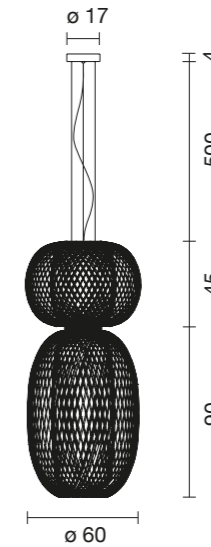
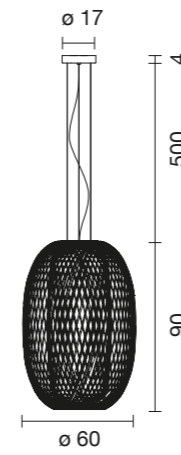
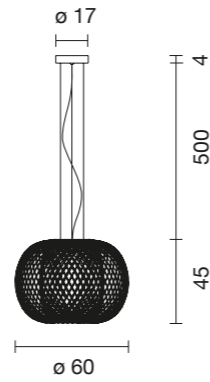
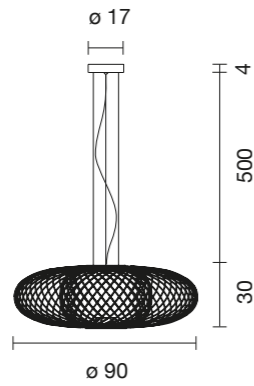

Type
Material
Light Source
Voltage
Dimming
Color Temperature (K)
Lumen Output (Lm)
CRI
IP Rating
Finishes

Suspension
Steel
2x LED Module 9W (Included)
110V, 220V
1-10V default, DALI & Phase cut available
2.700
1.440
90+
20
Graphite Matte
Golden Matte
Copper

11.8 kg
18.7 kg

Suspension
Steel
2x LED Module 9W (Included)
110V, 220V
1-10V default, DALI & Phase cut available
2.700
1.440
90+
20
Graphite Matte
Golden Matte
Copper

8.9 kg
13.7 kg

Suspension
Steel
2x LED Module 9W (Included)
110V, 220V
1-10V default, DALI & Phase cut available
2.700
1.440
90+
20
Graphite Matte
Golden Matte
Copper

13.8 kg
20.5 kg

Suspension
Steel
2x LED Module 9W (Included)
110V, 220V
1-10V default, DALI & Phase cut available
2.700
1.440
90+
20
Graphite Matte
Golden Matte
Copper

22.4 kg
37.9 kg

Floor
Steel
2x LED Module 9W (Included)
110V, 220V
2.700
1.440
90+
20
Graphite Matte
Golden Matte
Copper

41.8 kg
56.1 kg

Net Weight
Gross Weight

*All shape combinations are available.



B15

designed by Jordi Veciana

2014

The Collection

B15's intention is to enclose a beam of light. Featuring an aluminum structure & two LED tubes, encased within an extruded glass diffuser. This design allows for both vertical and horizontal orientations, offering versatility in installation.

Products

B15 T H PE
B15 T H GR
B15 T V PE
B15 T V GR

Discover more





The light source is enclosed in a premium extruded glass diffuser manufactured by german company Schott. The glass features an internal pattern generating an intriguing & elegant light diffusion.

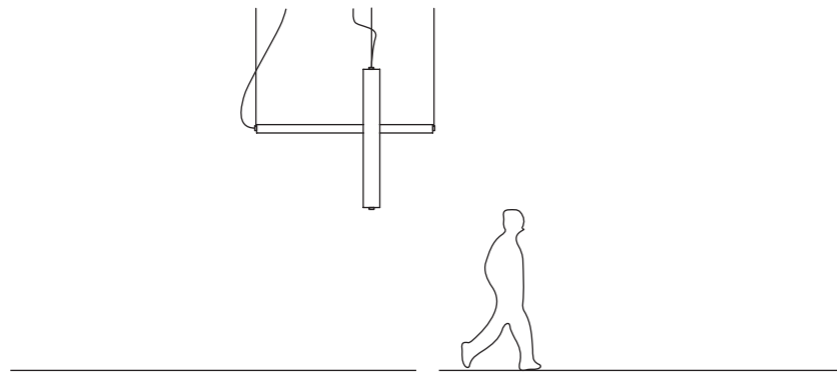

B15 T H GR

B15 T H PE

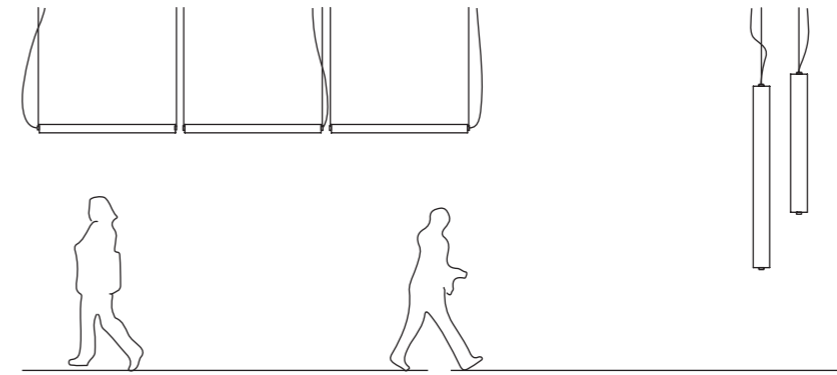

B15 T V GR

B15 T V PE

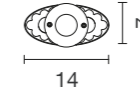
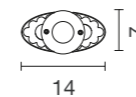
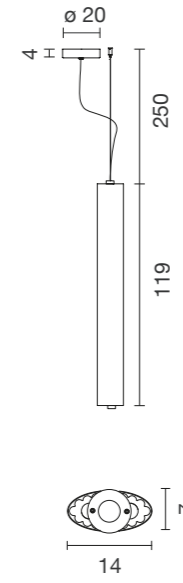
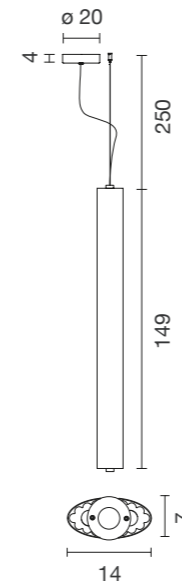
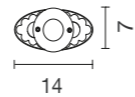
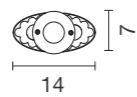
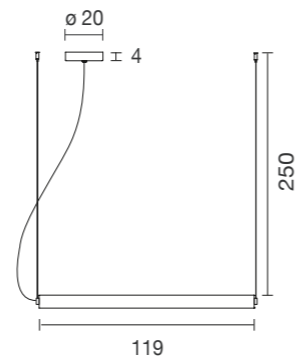
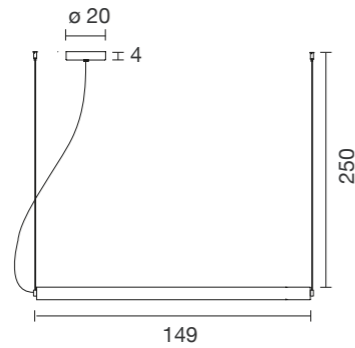

Type
Material
Light Source
Voltage
Dimming
Color Temperature (K)
Lumen Output (Lm)
CRI
IP Rating
Finishes

Suspension
Aluminum, Glass
2x Strip LED 28W (Included)
110V, 220V
1-10V default, DALI & Phase cut available
2.700
3.490
90+
20
Black Matte

Suspension
Aluminum, Glass
2x Strip LED 22W (Included)
110V, 220V
1-10V default, DALI & Phase cut available
2.700
2.743
90+
20
Black Matte

Suspension
Aluminum, Glass
2x Strip LED 28W (Included)
110V, 220V
1-10V default, DALI & Phase cut available
2.700
3.490
90+
20
Black Matte

Suspension
Aluminum, Glass
2x Strip LED 22W (Included)
110V, 220V
1-10V default, DALI & Phase cut available
2.700
2.743
90+
20
Black Matte

Net Weight
Gross Weight

7.1 kg
10.8 kg

5.5 kg
9.1 kg

7.1 kg
10.8 kg

5.5 kg
9.1 kg



Babel

designed by Stephen Burks

2014

The Collection

This collection features suspended lamps constructed from aluminum structures of varying heights and diameters. These components can be combined in multiple configurations, creating totem-like compositions. Each available in golden and black matte.

Products

Babel T PE
Babel T ME
Babel T GR

Discover more



This modular design allows for personalized arrangements, both in shapes and colors making distinct combinations.



Babel T PE

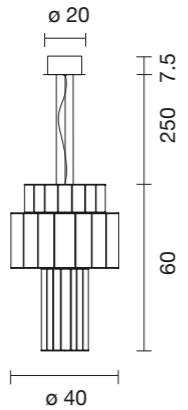

Babel T ME

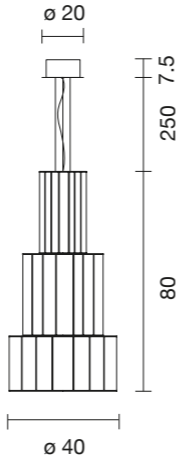

Babel T GR

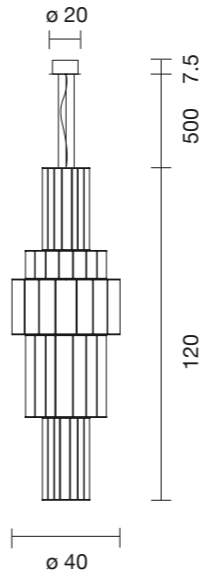

Type
 Material
 Light Source
 Voltage
 Dimming
 Color Temperature (K)
 Lumen Output (Lm)
 CRI
 IP Rating
 Finishes
 Net Weight
 Gross Weight

Suspension
 Aluminum
 Strip LED 19,5W + LED Module 14W (Included)
 110V, 220V
 1-10V default, DALI & Phase cut available
 2.700
 3.440
 90+
 20
 Black Matte
 Golden
 13.5 kg
 16.9 kg

Suspension
 Aluminum
 Strip LED 26,5W + LED Module 14W (Included)
 110V, 220V
 1-10V default, DALI & Phase cut available
 2.700
 3.960
 90+
 20
 Black Matte
 Golden
 15.6 kg
 19.8 kg

Suspension
 Aluminum
 Strip LED 42W + LED Module 14W (Included)
 110V, 220V
 1-10V default, DALI & Phase cut available
 2.700
 5.120
 90+
 20
 Black Matte
 Golden
 20.8 kg
 32.3 kg



Bai

designed by Neri&Hu

2014

The Collection

The Bai collection offers a modern interpretation of traditional Chinese lanterns. Combining blown glass with metal accents, these fixtures are available in pendant and wall versions for both indoors and outdoors.

Products

Bai A Di Di

Bai A Ba Ba

Bai T Di Di

Bai T Ma Ma

Bai T Ba Ba

Bai Chandelier II

Bai Chandelier III

Bai A Ba Ba Outdoor

Bai T Ma Ma Outdoor

Bai T Ba Ba Outdoor

Discover more





Artisanal, mouth blown glass diffusers available in transparent and amber.
A selection of models available for outdoors (IP-65).



Bai T Ma Ma (Indoor & Outdoor)

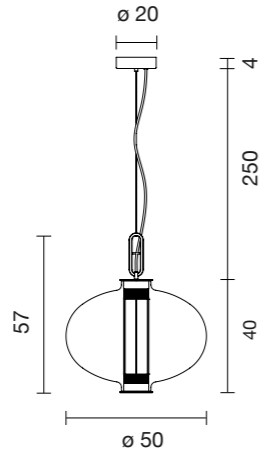

Bai T Ba Ba (Indoor & Outdoor)

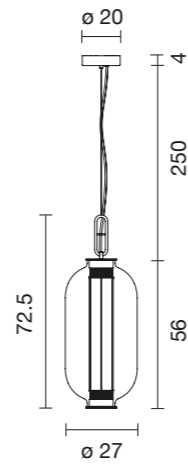

Bai T Di Di

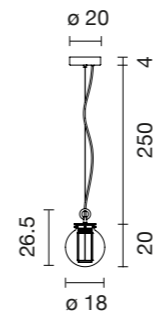

Bai Chandelier II

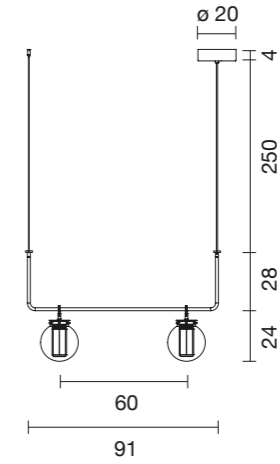

Bai Chandelier III

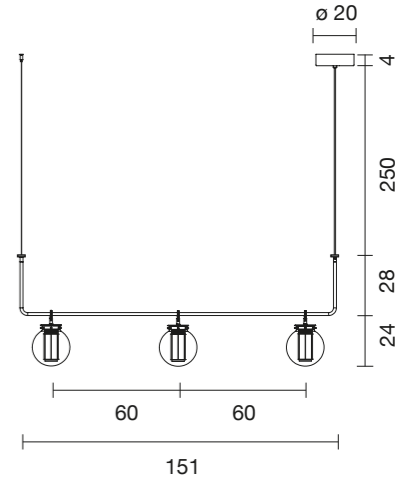

Type	Suspension	Suspension	Suspension	Suspension	Suspension
Material	Steel, Glass	Steel, Glass	Steel, Glass	Steel, Glass	Steel, Glass
Light Source	Strip LED 9,6W + LED Module 14W (Included)	Strip LED 15,4W + LED Module 14W (Included)	Strip LED 5,8W (Included)	2x Strip LED 5,8W (Included)	3x Strip LED 5,8W (Included)
Voltage	110V, 220V	110V, 220V	110V, 220V	110V, 220V	110V, 220V
Dimming	1-10V default, DALI & Phase cut available.	1-10V default, DALI & Phase cut available.	1-10V default, DALI & Phase cut available.	1-10V default, DALI & Phase cut available	1-10V default, DALI & Phase cut available
Color Temperature (K)	2.700	2.700	2.700	2.700	2.700
Lumen Output (Lm)	2.680	3.110	448	869	1.344
CRI	90+	90+	90+	90+	90+
IP Rating	20 (Outdoor: 65)	20 (Outdoor: 65)	20	20	20
Structure Finish	Aged Bronze (Outdoor: Dark Brown)	Aged Bronze (Outdoor: Dark Brown)	Aged Bronze	Aged Bronze	Aged Bronze
Glass Finishes	Transparent Amber	Transparent Amber	Transparent Amber	Transparent Amber	Transparent Amber
Net Weight	6.3 kg	6.5 kg	1.8 kg	4.3 kg	5.3 kg
Gross Weight	11.3 kg	9.1 kg	3.2 kg	6.9 kg	8.9 kg

Bai A Ba Ba (Indoor & Outdoor)

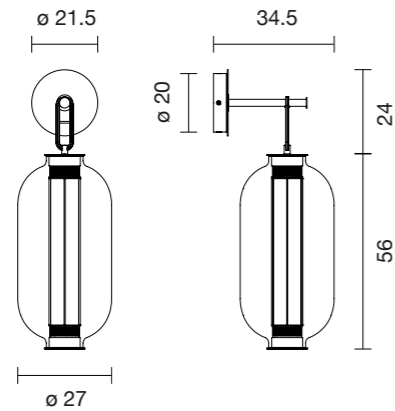

Bai A Di Di

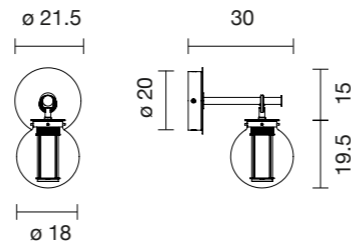

Type
Material
Light Source

Voltage
Dimming
Color Temperature (K)
Lumen Output (Lm)
CRI
IP Rating
Structure Finish
Glass Finishes

Net Weight
Gross Weight

Wall
Steel, Glass
Strip LED 15,4W + LED Module 14W (Included)
110V, 220V
1-10V default, DALI & Phase cut available
2.700
3.110
90+
20 (Outdoor: 65)
Aged Bronze (Outdoor: Dark Brown)
Transparent
Amber

6.6 kg
10.9 kg

Wall
Steel, Glass
Strip LED 5,8W (Included)
110V, 220V
1-10V default, DALI & Phase cut available
2.700
448
90+
20
Aged Bronze
Transparent
Amber

2.2 kg
4.8 kg





Chinoz

designed by Jaime Hayon

2013

The Collection

Asian-inspired table lamp that harmoniously blends traditional craftsmanship with contemporary design. Each lamp features a lacquered wood base, a ceramic body available in various finishes and a mouth-blown glass diffuser in satin opal white.

Discover more



PARACHILNA



- (01) Mouth blown glass diffuser in opal matt white
- (02) Handmade Italian ceramics from manufacturer Bosa®
- (03) Lacquered wood base
- (04) Exclusive Ming design graphic by Jaime Hayon

Production video



Chinoz

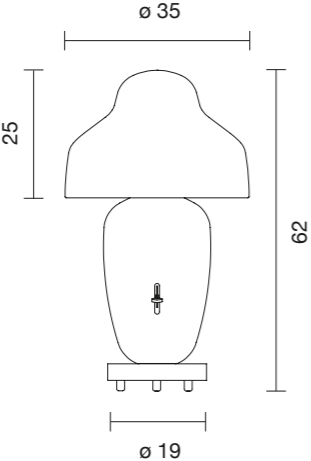

Type
 Material
 Light Source
 Voltage
 Dimming
 Color Temperature (K)
 IP Rating
 Finishes

Table
 Ceramic, Glass, Lacquered Wood
 E27 LED 15W (Not included)
 110V, 220V
 Dimming slider on ceramic structure
 2.700
 20
 Green Ceramic, Ocre Base
 Black Ceramic, Burgundy Base
 Ming Ceramic, Burgundy Bae

Net Weight
 Gross Weight

8.8 kg
 9.7 kg





Denglong

designed by Neri&Hu

2016

The Collection

Denglong is a collection luminaires that blend robust construction with refined aesthetics. Each fixture comprises a laser-cut aluminum and steel structure encasing a fiberglass diffuser, ensuring durability and an IP65 rating for both indoor and outdoor use.

Products

Denglong T PE
Denglong T GR
Denglong P PE
Denglong P GR

Denglong T PE Outdoor
Denglong T GR Outdoor
Denglong P PE Outdoor
Denglong T PE Outdoor

Discover more



For Indoor or Outdoor

IP20 / IP65



Denglong T PE (Indoor & Outdoor)

Denglong T GR (Indoor & Outdoor)

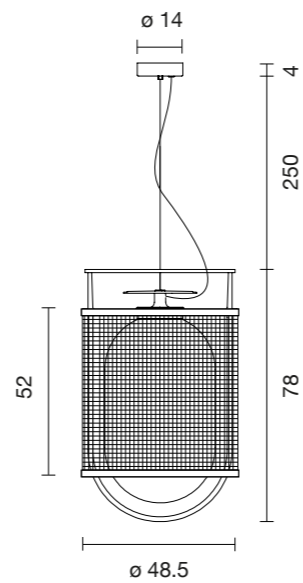
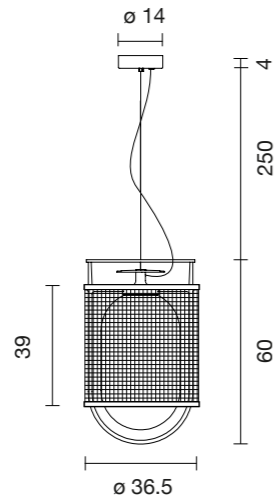

Denglong P PE (Indoor & Outdoor)

Denglong P GR (Indoor & Outdoor)

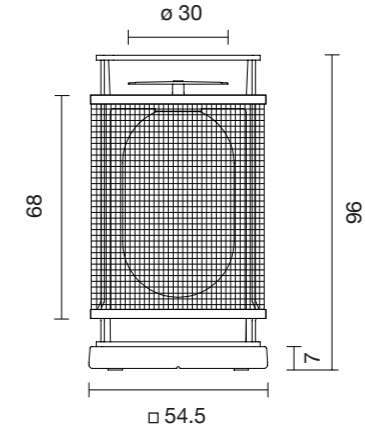
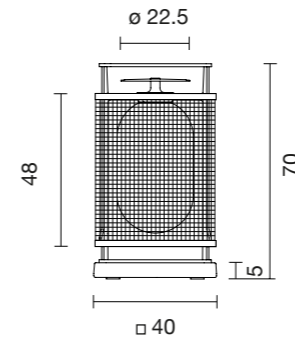

Type
Material
Light Source
Voltage
Dimming
Color Temperature (K)
Lumen Output (Lm)
CRI
IP Rating
Finishes

Suspension
Aluminum, Fiberglass
LED Module 8W (Included)
110V, 220V
Phase cut
2.700
800
90+
20 (Outdoor: 65)
Anthracite

Suspension
Aluminum, Fiberglass
LED Module 14W (Included)
110V, 220V
Phase cut
2.700
1.400
90+
20 (Outdoor: 65)
Anthracite

Floor
Aluminum, Fiberglass, Concrete
LED Module 8W (Included)
110V, 220V
2.700
800
90+
20 (Outdoor: 65)
Anthracite, Grey concrete base

Floor
Aluminum, Fiberglass, Concrete
LED Module 14W (Included)
110V, 220V
2.700
1.400
90+
20 (Outdoor: 65)
Anthracite, Grey concrete base

Net Weight
Gross Weight

6 kg
8 kg

12 kg
15 kg

21 kg
25 kg

48 kg
52 kg



The Collection

Each fixture is meticulously hand-sculpted in our atelier in Barcelona from thermoformed acrylic, creating unique pieces. The integrated LED strips within extruded aluminum profiles emit a soft, ambient glow, enhancing the ethereal quality of the design.

Products

Gweilo Han GR
Gweilo Han PE
Gweilo Qin GR
Gweilo Qin PE
Gweilo Song

Gweilo Zhou H PE
Gweilo Zhou H GR
Gweilo Zhou V PE
Gweilo Zhou V GR

Discover more





Each piece is hand molded acrylic by our team in Barcelona.

Production video





Gweilo Han GR

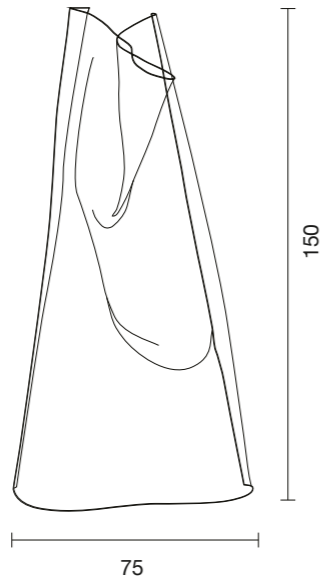

Gweilo Han PE

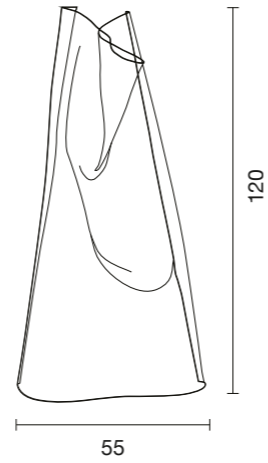

Gweilo Qin GR



Gweilo Qin PE



Gweilo Song

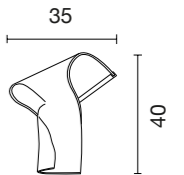

Type
Material
Light Source
Voltage
Dimming
Color Temperature (K)
Lumen Output (Lm)
CRI
IP Rating
Finishes

Net Weight
Gross Weight

Floor
Acrylic
Strip LED 14W (Included)
110V, 220V
Dimmer switch on cable
3.000
1.348
90+
20
Golden
Silver

10 kg
13 kg

Floor
Acrylic
Strip LED 11W (Included)
110V, 220V
Dimmer switch on cable
3.000
1.069
90+
20
Golden
Silver

5 kg
7 kg

Floor
Acrylic
Strip LED 14W (Included)
110V, 220V
Dimmer switch on cable
3.000
1.348
90+
20
Golden
Silver

10 kg
13 kg

Floor
Acrylic
Strip LED 11W (Included)
110V, 220V
Dimmer switch on cable
3.000
1.069
90+
20
Golden
Silver

5 kg
7 kg

Table
Acrylic
Strip LED 2,5W (Included)
110V, 220V
Dimmer switch on cable
3.000
232
90+
20
Golden
Silver

1.5 kg
3 kg

Gweilo Zhou V PE

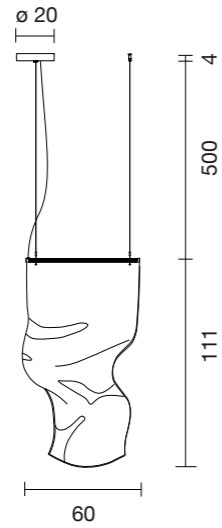

Gweilo Zhou V GR

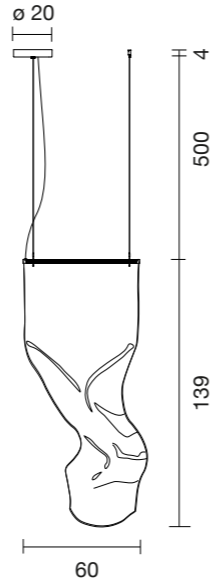

Gweilo Zhou H PE

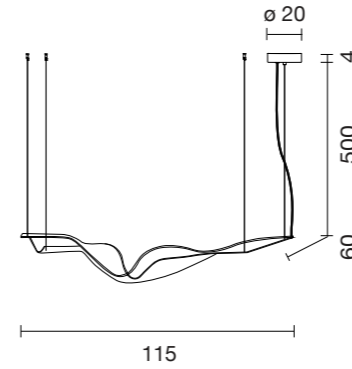

Gweilo Zhou H GR

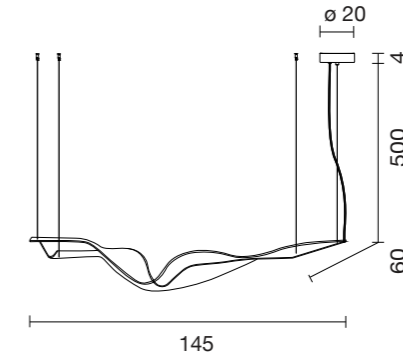

Type	Suspension
Material	Acrylic
Light Source	Strip LED 5,3W (Included)
Voltage	110V, 220V
Dimming	1-10V default, DALI & Phase cut available
Color Temperature (K)	3.000
Lumen Output (Lm)	500
CRI	90+
IP Rating	20
Finishes	Golden Silver
Net Weight	4.8 kg
Gross Weight	8 kg

Type	Suspension
Material	Acrylic
Light Source	Strip LED 5,3W (Included)
Voltage	110V, 220V
Dimming	1-10V default, DALI & Phase cut available
Color Temperature (K)	3.000
Lumen Output (Lm)	500
CRI	90+
IP Rating	20
Finishes	Golden Silver
Net Weight	6.8 kg
Gross Weight	9 kg

Type	Suspension
Material	Acrylic
Light Source	Strip LED 5,3W (Included)
Voltage	110V, 220V
Dimming	1-10V default, DALI & Phase cut available
Color Temperature (K)	3.000
Lumen Output (Lm)	500
CRI	90+
IP Rating	20
Finishes	Golden Silver
Net Weight	4.8 kg
Gross Weight	8 kg

Type	Suspension
Material	Acrylic
Light Source	Strip LED 5,3W (Included)
Voltage	110V, 220V
Dimming	1-10V default, DALI & Phase cut available
Color Temperature (K)	3.000
Lumen Output (Lm)	500
CRI	90+
IP Rating	20
Finishes	Golden Silver
Net Weight	6.8 kg
Gross Weight	9 kg



Lighto

designed by Jaime Hayon

2016

The Collection

The Lighto collection exemplifies minimalist elegance through its slender steel construction and distinctive finishes. This family includes wall, floor, suspension, and ceiling versions, each for versatile uses.

Products

Lighto T PE
Lighto T GR
Lighto P
Lighto A
Lighto A II
Lighto C PE
Lighto C GR

Discover more







Lighto T GR

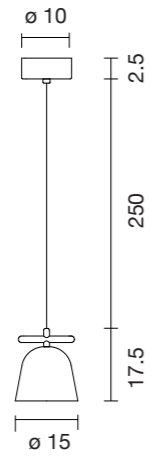

Lighto T PE

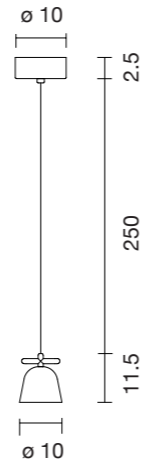

Lighto P

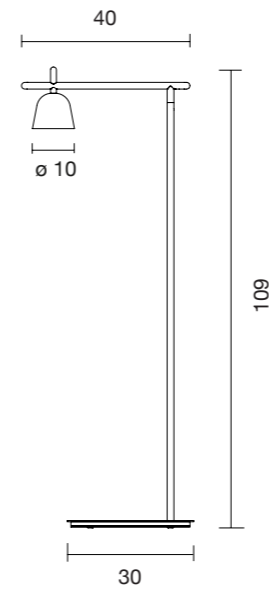

Lighto A

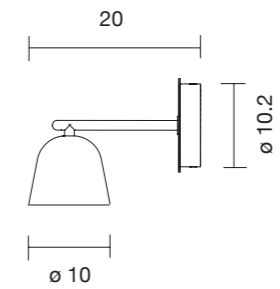

Lighto A II

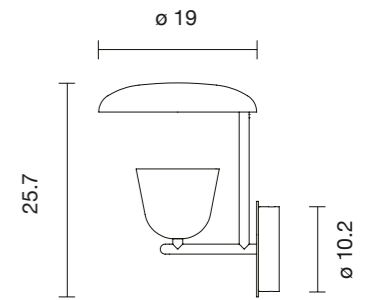

Type	Suspension
Material	Steel
Light Source	LED COB 12W (Included)
Voltage	110V, 220V
Dimming	
Color Temperature (K)	2.700
Lumen Output (Lm)	997
CRI	90+
IP Rating	20
Finishes	Black Matte, Golden Glossy Cup Black Matte, Black Chrome Cup
Net Weight	1.1 kg
Gross Weight	2 kg

Type	Suspension
Material	Steel
Light Source	LED COB 6W (Included)
Voltage	110V, 220V
Dimming	
Color Temperature (K)	2.700
Lumen Output (Lm)	475
CRI	90+
IP Rating	20
Finishes	Black Matte, Golden Glossy Cup Black Matte, Black Chrome Cup
Net Weight	0.7 kg
Gross Weight	1.5 kg

Type	Floor
Material	Steel
Light Source	LED COB 6W (Included)
Voltage	110V, 220V
Dimming	Dimmer switch on cable
Color Temperature (K)	2.700
Lumen Output (Lm)	475
CRI	90+
IP Rating	20
Finishes	Black Matte, Golden Glossy Cup Black Matte, Black Chrome Cup
Net Weight	6.3 kg
Gross Weight	7.8 kg

Type	Wall
Material	Steel
Light Source	LED COB 6W (Included)
Voltage	110V, 220V
Dimming	
Color Temperature (K)	2.700
Lumen Output (Lm)	475
CRI	90+
IP Rating	20
Finishes	Black Matte, Golden Glossy Cup Black Matte, Black Chrome Cup
Net Weight	1.5 kg
Gross Weight	2 kg

Type	Wall
Material	Steel
Light Source	LED COB 6W (Included)
Voltage	110V, 220V
Dimming	
Color Temperature (K)	2.700
Lumen Output (Lm)	475
CRI	90+
IP Rating	20
Finishes	Black Matte, Golden Glossy Cup Black Matte, Black Chrome Cup
Net Weight	0.5 kg
Gross Weight	1 kg

Lighto C GR

Lighto C PE

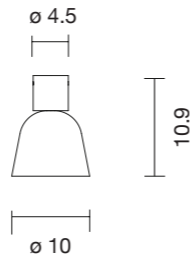
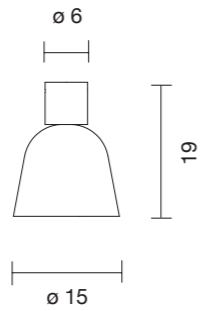

Type	Ceiling
Material	Steel
Light Source	LED COB 12W (Included)
Voltage	110V, 220V
Color Temperature (K)	2.700
Lumen Output (Lm)	997
CRI	90+
IP Rating	20
Finishes	Black Matte, Golden Glossy Cup Black Matte, Black Chrome Cup
Net Weight	0.9 kg
Gross Weight	1.5 kg

Type	Ceiling
Material	Steel
Light Source	LED COB 6W (Included)
Voltage	110V, 220V
Color Temperature (K)	2.700
Lumen Output (Lm)	475
CRI	90+
IP Rating	20
Finishes	Black Matte, Golden Glossy Cup Black Matte, Black Chrome Cup
Net Weight	0.5 kg
Gross Weight	1 kg





Ma-Rock

designed by Jaime Hayon

2020

The Collection

Ma-Rock blends traditional Moroccan aesthetics with contemporary design. Featuring perforated metal shades that cast intricate patterns of light and shadow, this collection offers pendant and table versions.

Products

Ma-Rock T PE
Ma-Rock T ME
Ma-Rock T GR
Ma-Rockl M

Discover more





Ma-Rock T GR

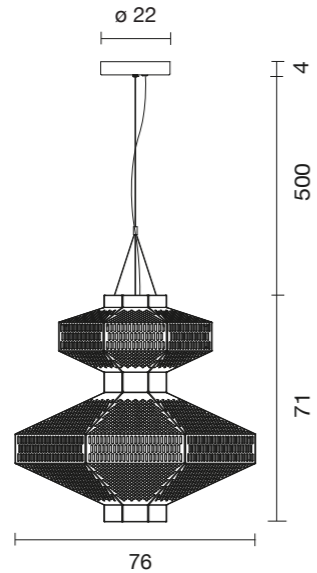

Ma-Rock T ME

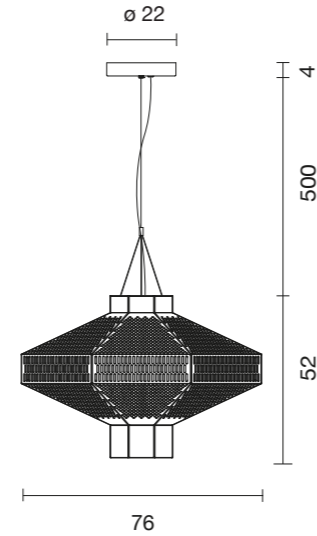

Ma-Rock T PE

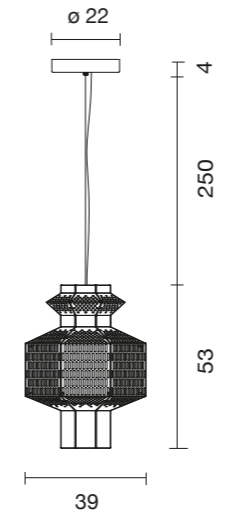

Ma-Rock M

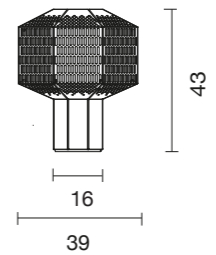

Type
Material
Light Source
Voltage
Dimming
Color Temperature (K)
Lumen Output (Lm)
CRI
IP Rating
Finishes

Suspension
Steel
2X LED Module 14W (Included)
110V, 220V
1-10V default, DALI & Phase cut available
2.700
3.932
90+
20
Golden

Suspension
Steel
2X LED Module 9W (Included)
110V, 220V
1-10V default, DALI & Phase cut available
2.700
2.880
90+
20
Golden

Suspension
Steel
2X LED Module 9W (Included)
110V, 220V
1-10V default, DALI & Phase cut available
2.700
2.880
90+
20
Golden

Table
Steel
LED COB 12W (Included)
110V, 220V
Dimmer switch on cable
2.700
997
90+
20
Golden

Net Weight
Gross Weight

12.9 kg
17.5 kg

9.8 kg
14.7 kg

4.9 kg
8.8 kg

3 kg
4.2 kg



Manila

designed by Sebastian Herkner

2019

The Collection

The Manila collection draws inspiration from the traditional Spanish “Mantón de Manila” silk shawl, commonly associated with flamenco dancers. This collection elegantly combines artisanal blown glass with a plissé textile diffuser, resulting in a sophisticated lighting family.

Products

Manila T PE
Manila T GR
Manila C PE
Manila C GR

Discover more







Manila T PE

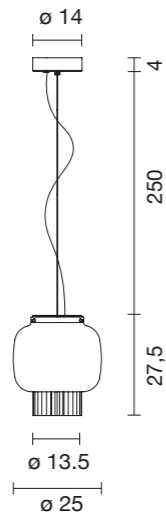

Manila T GR

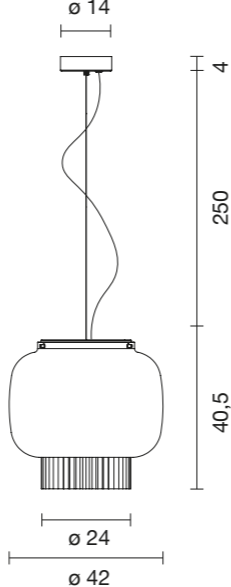

Manila C PE

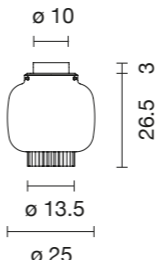

Manila C GR

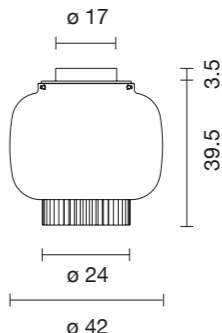

Type	Suspension
Material	Steel, Glass, Textile
Light Source	E27 LED 13W (Not included)
Voltage	110V, 220V
Dimming	Terminal strip
IP Rating	20
Finishes	Golden, Beige Textile, Transparent Glass Graphite, Grey Textile, Black Glass
Net Weight	2.4 kg
Gross Weight	4.3 kg

Type	Suspension
Material	Steel, Glass, Textile
Light Source	E27 LED 18W (Not included)
Voltage	110V, 220V
Dimming	Terminal strip
IP Rating	20
Finishes	Golden, Beige Textile, Transparent Glass Graphite, Grey Textile, Black Glass
Net Weight	5.5 kg
Gross Weight	8.2 kg

Type	Ceiling
Material	Steel, Glass, Textile
Light Source	E27 LED 13W (Not included)
Voltage	110V, 220V
Dimming	Terminal strip
IP Rating	20
Finishes	Golden, Beige Textile, Transparent Glass Graphite, Grey Textile, Black Glass
Net Weight	2.4 kg
Gross Weight	4.3 kg

Type	Ceiling
Material	Steel, Glass, Textile
Light Source	E27 LED 18W (Not included)
Voltage	110V, 220V
Dimming	Terminal strip
IP Rating	20
Finishes	Golden, Beige Textile, Transparent Glass Graphite, Grey Textile, Black Glass
Net Weight	5.5 kg
Gross Weight	8.2 kg



Oïphorique

designed by Atelier Oï

2014

The Collection

The Oïphorique collection, designed by Atelier Oï, features a tall steel structure draped with a light gray pleated textile diffuser. The lamp includes a motor that generates an up-and-down movement, creating a dynamic deformation of the diffuser. The structure houses two LED tubes that emit a warm light. The collection is available in two sizes for both floor and ceiling.

Products

Oïphorique T PE
Oïphorique T GR
Oïphorique P PE
Oïphorique P GR
Oïphorique P PE Still
Oïphorique P GR Still

Discover more



The lamp features two independent switches — one controlling the light, the other the movement.
Scan the code to see it come to life.



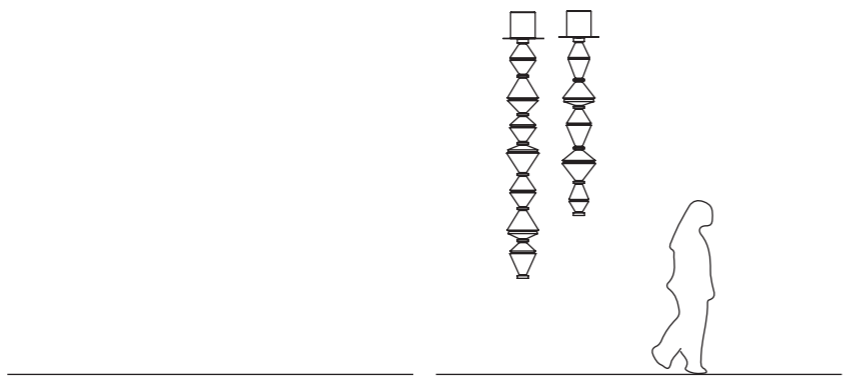

Oïphorique P PE

Oïphorique P GR

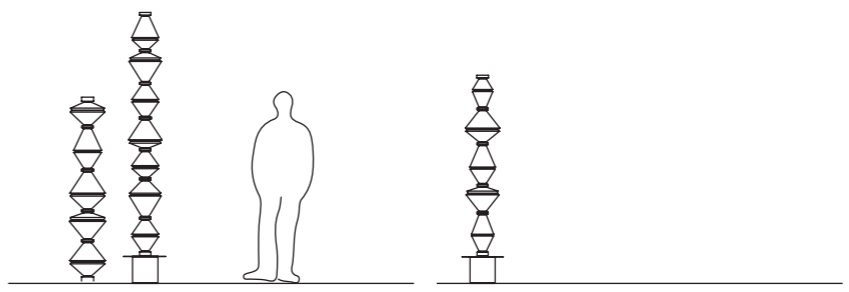

Oïphorique T PE

Oïphorique T GR

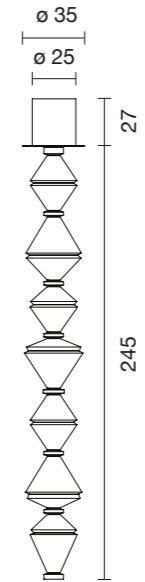
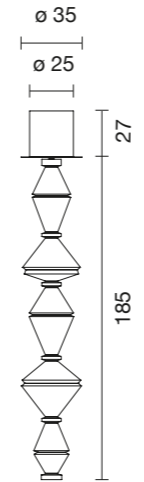
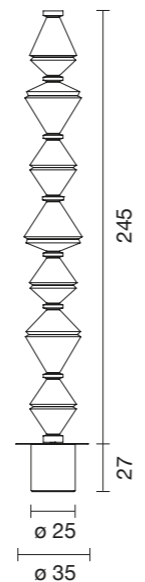
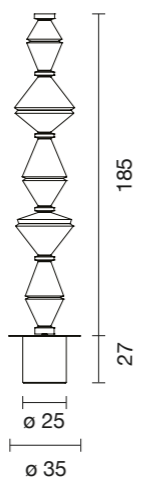

Type
Material
Light Source
Voltage
Dimming
Color Temperature (K)
Lumen Output (Lm)
CRI
IP Rating
Finishes

Ceiling
Steel, Textile
Strip LED 31W (Included)
110V, 220V
On/off switch on base
2.700
2.624
90+
20
Pearl White, Apricot, Light Grey,
Chocolate Brown, Snow Mint

Ceiling
Steel, Textile
Strip LED 42W (Included)
110V, 220V
On/off switch on base
2.700
3.608
90+
20
Pearl White, Apricot, Light Grey,
Chocolate Brown, Snow Mint

Ceiling
Steel, Textile
Strip LED 31W (Included)
110V, 220V
1-10v default, DALI & Phase cut available
2.700
2.624
90+
20
Pearl White, Apricot, Light Grey,
Chocolate Brown, Snow Mint

Ceiling
Steel, Textile
Strip LED 42W (Included)
110V, 220V
1-10v default, DALI & Phase cut available
2.700
3.608
90+
20
Pearl White, Apricot, Light Grey,
Chocolate Brown, Snow Mint

Net Weight
Gross Weight

15.7 kg
23.8 kg

16.2 kg
24.9 kg

7.6 kg
15.9 kg

10.1 kg
13.5 kg

Oïphorique P PE Still

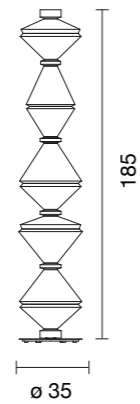

Oïphorique P GR Still

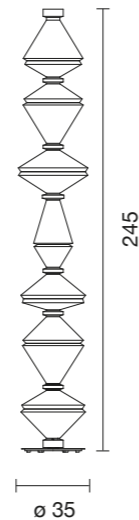

Type
Material
Light Source
Voltage
Dimming
Color Temperature (K)
Lumen Output (Lm)
CRI
IP Rating
IP Rating
Finishes

Ceiling
Steel, Textile
Strip LED 31W (Included)
110V, 220V
On/off switch on cable
2.700
2.624
90+
20
Pearl White, Apricot, Light Grey,
Chocolate Brown, Snow Mint

Net Weight
Gross Weight

14.7 kg
22.8 kg

Ceiling
Steel, Textile
Strip LED 42W (Included)
110V, 220V
On/off switch on cable
2.700
3.608
90+
20
Pearl White, Apricot, Light Grey,
Chocolate Brown, Snow Mint

15.2 kg
23.9 kg





Petra

designed by Jordi Veciana

2020

The Collection

Petra epitomizes minimalist elegance through its use of natural alabaster. Each lamp features a cylindrical base and a conical shade, both meticulously carved from a single piece of this translucent stone, allowing for a warm, ambient glow.

Products

Petra M PE
Petra M ME
Petra M GR

Discover more



Carved out of a solid block of alabaster.



Petra M PE

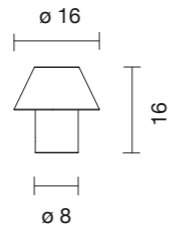

Type Table
 Material Alabaster
 Light Source E27 LED Filament A45 4W
 Voltage 110V, 220V
 Dimming Dimmer switch on cable
 Color Temperature (K) 2.700
 IP Rating 20
 Net Weight 2.2 kg
 Gross Weight 2.4 kg

Petra M ME

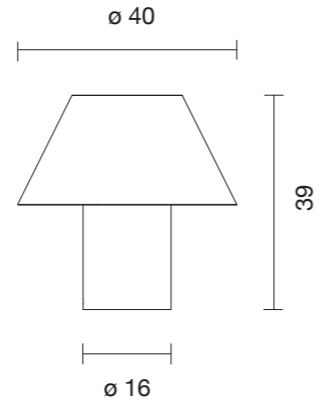

Type Table
 Material Alabaster
 Light Source E27 LED A60 15W Dimm. (Not included)
 Voltage 110V, 220V
 Dimming Dimmer switch on cable
 IP Rating 20
 Net Weight 10 kg
 Gross Weight 14.7 kg

Petra M GR

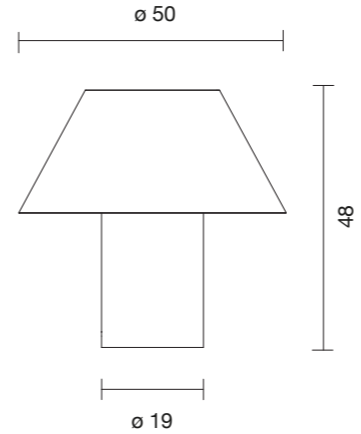

Type Table
 Material Alabaster
 Light Source E27 LED A70 15W Dimm. (Not included)
 Voltage 110V, 220V
 Dimming Dimmer switch on cable
 IP Rating 20
 Net Weight 16.2 kg
 Gross Weight 23.3 kg



Topuro

designed by Guido Valín

2025

The Collection

Topuro is a lamp born from the desire to work with the idea of the dematerialization of light—how it moves through space while gradually losing its intensity. To achieve this, it employs the concept of a series as a metaphorical gradual progression.

Products

- Topuro S
- Topuro L
- Topuro L Outdoor

Discover more





Topuro S

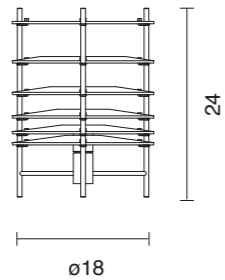

Topuro L

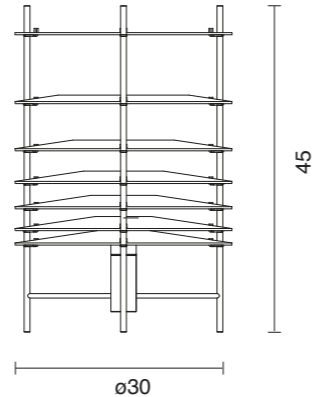

Topuro L Outdoor

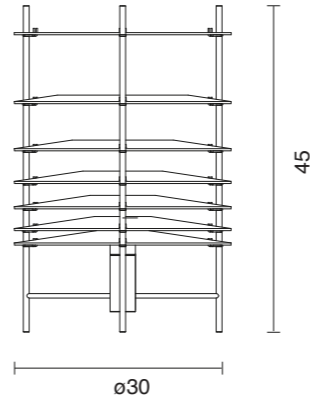

Type
 Material
 Light Source
 Voltage
 Color Temperature (K)
 IP Rating

Table
 Stainless steel, Acrylic
 G4 LED 2W (Included)
 110V, 220V
 2.700
 20

Table / Floor
 Stainless steel, Acrylic
 G9 LED 5.5W
 110V, 220V
 2.700
 20

Table / Floor
 Stainless steel, Acrylic
 G9 LED 5.5W
 110V, 220V
 2.700
 65

Net Weight
 Gross Weight

0.8 kg
 1.6 kg

2.3 kg
 3.9 kg

2.3 kg
 3.9 kg

Direction
Parachilna

Photography
Kiwi Bravo
Matu Marsicano
Nua Galí
Irina Boersma

CGI
Bernat Pibernat

Design
Partida Continua
Socis Club

Print
Imprenta Tormiq S.L.

All rights reserved, 2025
© of all content: The Authors

Download the digital version



Recinto industrial Colonia Güell

C/ Tallers 28
08690, Santa coloma de Cervellò
Barcelona / Spain
T +34 930 462 700

hello@parachilna.eu
www.parachilna.eu

Awarded by

Wallpaper*
ELLE DECOR

All products are Made in Spain.

For sustainability purposes and long-term durability,
our collections are fully demountable and repairable.

